

KYEC® Safety Power Rails

Application of Crane · Hoist · Warehouse · Kinds of Assemble Line

Appointed
Mark
KYEC

ISO 9001
Certificated
Since Year
2000



Index	Introduction	P1	3P-6P installment diagram	
	Choose suitable type and amperes	P2	I type safety power rail design	P14
	3P-6P safety power rail design	P3	I type safety power rail parts diagram	P15
	3P-6P parts diagram	P4	I type safety power rail installment diagram	P17
	High temperature durable box safety power rail	P10	Our performance sample	end cover

Introduction :

Being specialized in hoist repair and related innovation, KYEC provide our customers with excellent service based persistent devotion, responsibility and advanced technology.

In order to overcome the difficulties that we have been confronted with part importing, we dedicate ourselves to the production and innovation of parts and components. Also we have obtained numerous patents approved by R.O.C (Taiwan) and overseas countries.

KYEC supply our customers with readily available engineering materials and technical assistance to shorten time of preparation.

Safety power rails

The safety power rails are electrical conductors of various profiles that are used to provide electrical potential to moving systems along a path of travel which have 3-6 poles.

The safety power rails are available for a current load from 60A up to 200A mobile electrification technology for moving transportation vehicles and equipment. Common application include: manufacturing robots, material handling systems, hoist and cranes, automated storage facilities and retrieval systems.

Safety power rail systems are available in a variety of configuration depending on applications requirements. Enclosed conductor systems typically enclosed conductors in a protective conduit meeting safety standard.



General technical information

Conversion Table of Horse Power

Full Load Current Table of 3 Phase Alternating

H.P	110V	220V	440V	550V	2300V
1/2	4	2	1	0.8	
3/4	5.6	2.8	1.4	1.1	
1	7	3.5	1.8	1.4	
1 1/2	10	5	2.5	2.0	
2	13	6.5	3.3	2.6	
3		9	4.5	4	
5		15	7.5	6	
7 1/2		22	11	9	
10		27	14	11	
15		40	20	16	
20		52	26	21	
25		64	32	26	7
30		78	39	31	8.5
40		104	52	41	10.5
50		125	63	50	13
60		150	75	60	16
75		180	93	74	19
100		246	123	98	25
125		310	155	124	31
150		360	180	144	37
200		480	240	192	48

Check the steps below first to select the correct current (Ampere) of safety power rails and current collector :

1. Calculate the total motor's Horse Power(H.P) required. (ex.10H.P)
2. Make sure the rated voltage(V) is 220V.
3. Get the current data by checking the above conversion table. (ex.27 Ampere)

Safety Current Table of Conductor Wire Assembling

The safety current of safety power rails would perhaps be affected if the circuit temperature is over 35°C

Copper Conductor Wire			60°C	75°C	80°C	90°C
Category of Conductor Wire	Dimension mm ²	No. of Wire/Diameter mm	Insulator	Insulator	Insulator	Insulator
			Ampere Capacity(A)			
Single Wire		1.6	20			
		2.0	30			
		2.5	40			
Strand Wire	2.0	7/0.6	20			
	3.5	7/0.8	20			
	5.5	7/1.0	40			
	8	7/1.2	55	65	70	80
	14	7/1.6	80	95	100	110
	22	7/2.0	100	125	135	145
	30	7/2.3	125	150	160	170
	38	7/2.6	145	180	190	205
	50	19/1.8	175	210	220	245
	60	19/2.0	200	240	250	280
	80	19/2.3	230	285	300	330
	100	19/2.6	270	330	350	38
	125	19/2.9	310	380	400	440
	150	37/2.3	360	440	460	505
	200	37/2.6	425	520	550	600
250	61/2.3	505	615	650	710	
325	61/2.6	590	720	760	830	
400	61/2.9	680	825	870	955	
500	61/3.2	785	930	985	1080	

Horse power =total kws/0.75; A = Horse Power×3; (on the assumption 220V)

Total current [A.] ×1.25=proper current

According to the ampere quantity, choose the type of safety power rail:

90A -200A: 3-6P safety power rail

150A: I type safety power rail

120A 320A 500A 800A: W type safety power rail

Vertical design

- 3P for 3 phase on R.S.T
- 4P for 3 phase on R.S.T and one ground wire
- 5p for 3 phase on R.S.T and two control line
- 6P for 3 phase on R.S.T and three line for saddle motor

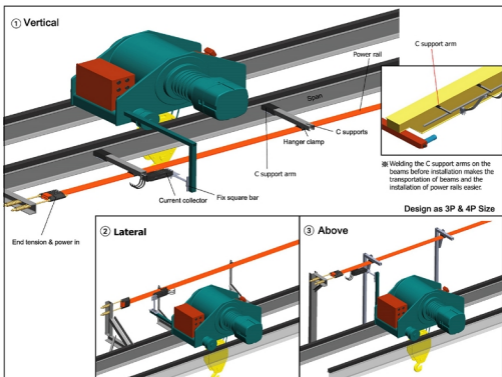
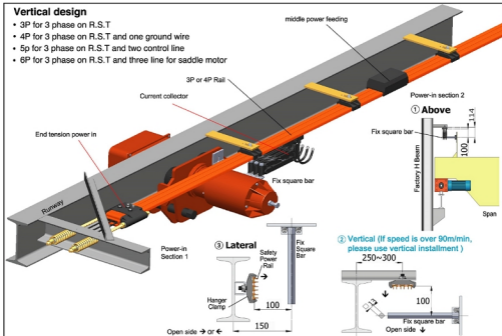

3P Safety power rail

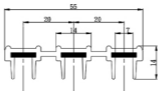

OFC 3N(99.9% good conductivity)

3P (Phase) Safety Power Rail				
Type	Capacity (A)	Thickness (mm)	Width (mm)	Weight (kg/m)
KY-AN3007	75	2	10	0.8
KY-AN3010	100	2.8	10	1.03
KY-AN3015	150	3	10	1.14



Use with C Track Support and C Plate M10 Nut 30x20x5'



KY-AN3100
3P Hanger Clamp

0.075 kg / pc

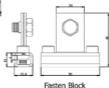
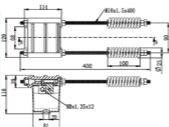
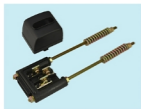

Fastener Block

KY-AN3200
3P End Tension & Power in

1.73 kg / pc

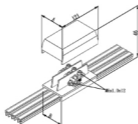

Type	Size	A	B
3P		70	62
4P		90	82
6P		130	122

KY-AN3300
3P Middle Power Feed-in

0.21 kg / pc

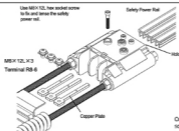

1. Insert safety power rail into the hole.
2. Use M8 x 12L hex socket screw to fix and tense the safety power rail. (only two and half cycle needed when screw meet the safety power rail)
3. Power lines fixed with terminals, and fasten the copper power plate.

Power rail PVC peel free!

KY-AN3200N
3P End Tension & Power in

1.5 kg / pc

4P Safety power rail

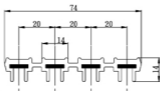

OFC 3N (99.9% good conductivity)

4P (Phase) Safety Power Rail				
Type	Capacity (A)	Thickness (mm)	Width (mm)	Weight (Kg/m)
KY-AN4007	75	2	10	1.1
KY-AN4010	100	2.8	10	1.4

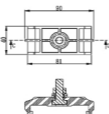

Use with C Track Support and C Plate M10 Nut 30 x 20 x 8'



KY-AN4100
4P Hanger Clamp
0.083 kg / pc

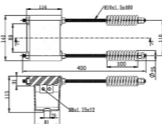

KY-AN4200
End Tension & Power in
1.74 kg / pc

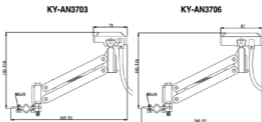

KY-AN3703
30A Current Collector
0.24 kg / pc

KY-AN3706
60A Current Collector
0.27 kg / pc

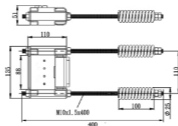

Power rail PVC peel free!

KY-AN4200N
End Tension & Power in
1.28 kg / pc

5P Safety power rail

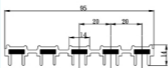
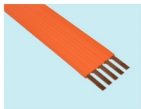

OFC 3N(99.9% good conductivity)
Conductor Cross Section: $2.81 \times 10 = 28 \text{ mm}^2$

5P (Phase) Safety Power Rail				
Type	Capacity (A)	Thickness (mm)	Width (mm)	Weight (kg/m)
KY-AN5009	100	2.8	10	1.7

5P power rails use the same middle tension as 6P.

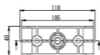
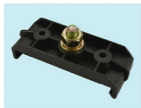

Use with C Track Support
and C Plate M10 Nut
 $30 \times 20 \times 5'$

KY-AN5100
Hanger Clamp

0.09 kg / pc

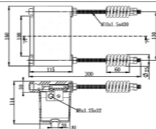

KY-AN5200

5P Middle Tension
& Power in

1.75 kg / pc

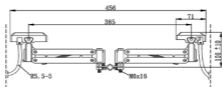

Made to Order

Twin Current
Collector



KY-AN3800

Fix Square Bar

0.7 kg / pc

6P Safety power rail

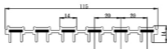
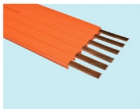

OFC 3N (99.9%, good conductivity)

6P (Phase) Safety Power Rail				
Type	Capacity (A)	Thickness (mm)	Width (mm)	Weight (kg/m)
KY-AN6007	75	2	10	1.64
KY-AN6010	100	2.8	10	2.06

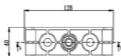

Use with C Track Support
and C Plate M10 Nut
30x20x5¹



KY-AN6100
6P Hanger Clamp

0.1 kg / pc

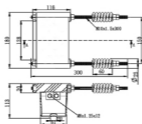

KY-AN6200
6P End Tension &
Power in

1.9 kg / pc

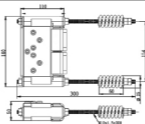

Power rail PVC peel free!

KY-AN6200N
6P End Tension &
Power in

1.9 kg / pc

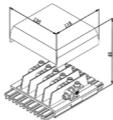

KY-AN6300
6P Middle Tension &
Power in

0.38 kg / pc

3P 200A Parts Diagram

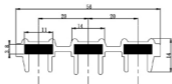

OFC 3N (99.9%, good conductivity)
Conductor Cross Section: 3.8"11w=41.8mm²

3P(Phase)Safety Power Rail		
Type	Standard	kg/m
KY-AN3020	200 Amp	1.42

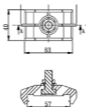

Use with C Track Support
and C Plate M10 Nut
30 X 20 X 5"



KY-AN3120	
3P Hanger Clamp	
0.075 kg / pc	

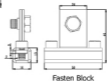
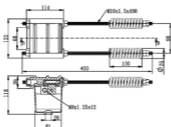

KY-AN3220	
3P End Tension & Power in	
1.75 kg / pc	

KYEC Safety Power Rail Test Result

Test Type	Material	Resistance coefficient (R/M)	Durable Potential	Decay of Potential(V/M)	220V/100m Decay Percentage	Temperature
W type 600A	Aluminum	0.000100	8KV X 30min	0.08	3.8%	23
W type 500A	Aluminum	0.000107	8KV X 30min	0.054	2.5%	23
W type 320A	Aluminum & Copper	0.000184	8KV X 30min	0.059	2.7%	23
3P 100A	Copper	0.000630	8KV X 30min	0.057	2.6%	23
3P 100A	Copper & Stainless Steel	0.000512	8KV X 30min	0.047	2.1%	23
3P 75A	Copper	0.000882	8KV X 30min	0.066	3.0%	23

Assay Institute : Industrial Technology Research Institute

Assay Instrument:

Brand & Model :
EST 242D
KIKUSUI TOS-8700
TAMA-TDV-20ADS

Name of Instrument :
PRECISION RES.MEASUREMENT SYSTEM
WITH INING VOLTAGE TESTER
HIGH VOLTAGE DIGITAL METER

3P 100A (Copper)

Length(m)	10	20	30	40	50	60	70	80	90	100
Decay of Potential(V)	0.57	1.14	1.71	2.28	2.85	3.42	3.99	4.56	5.13	5.70

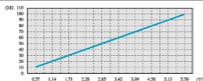

3P 100A (Stainless Steel)

Length(m)	10	20	30	40	50	60	70	80	90	100
Decay of Potential(V)	0.47	0.94	1.41	1.88	2.35	2.82	3.29	3.76	4.23	4.70

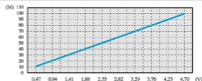

High Temperature Durable Box Safety Power Rail

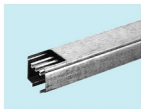

KY-D3003 (6133)
ND3P Straight
Line Duct
3 kg / M

KY-D3702 (6175)
ND3P Trolley
20A
0.7 kg / pc

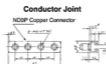

KY-D3500 (61331)
ND3P Coupling
Plate
0.3 kg / pc

KY-D3704 (6276)
ND3P Trolley
40A
0.8 kg / pc



KY-D3100 (6111)
ND3P Hanger
0.3 kg / pc

KY-D3600 (6117)
ND3P Trolley-
Pulling Bracket



KY-D3201 (6112)
ND3P End Cap
0.4 kg / pc

KY-D3001 (6001)
ND3P Trolley Collectors
KY-D3902 (6102)
ND3P Trolley Collectors 25A
KY-D3904 (6104)
ND3P Trolley Collectors 40A

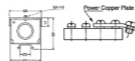

KY-D3200 (6173)
ND3P Feed-in
Boxes
1.2 kg / pc

Produce on Demand
Curved Duct



3P、4P、5P、6P Installments Diagram

Step 1 Support Design

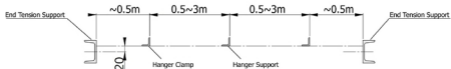

Remark :

- (1) The side design installment recommended when a camber occurs to the 3-6P safety power rail assembly.
- (2) The hanger clamps are supposed to be installed every 0.5 meter from the starting point of the turning.
- (3) The 3-6P tension part for safety power rails must be installed at the place about 10mm higher than the hanger clamp.

This step prevents water from flowing to the power-in place along the safety power rails; hence the short circuit won't happen.

- (4) The silica gel must be coated on the connected place of the power-in part and safety power rail as weather protection.
- (5) The 3-6P safety power rails are not suitable for outdoor usage or the place with high acid/alkali environments.

Step 2 End tension & Power-in

Remark : (1) Install one end on the ground then lift rail up to estimated location and install another.

Step 3 Hanger clamp

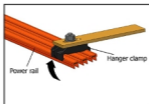
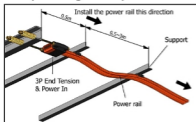

(1) Aim the hanger clamp with power rail and push up.

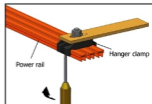

(2) Use a slotted screwdriver to dismantle the hanger clamp.

Step 4 End tension & Power-in

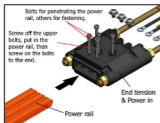

4-1

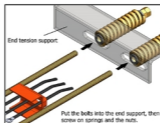

4-2

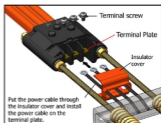

4-3

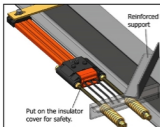

4-4

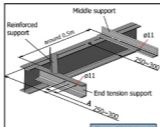

4-5

Tension Middle Length	A
3P	90
4P	110
5P	130
6P	150
7P	170

★ To avoid short circuit, please fasten the terminal plate with M8 x 16mm socket screws.

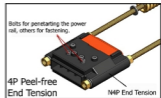

Step 5 Fix square bar/current collector

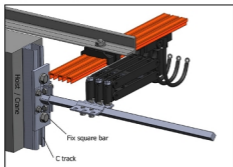

Remark:

- (1) Fix square bar could be welded on the crane or screw used.
- (2) Fix square bar's angle is supposed to be mounted. One diagonal of the bar must be parallel to ground and safety power rail, another is verticle.
- (3) Length could be cut as demand.
- (4) If carbon brushes worn, just replace a new one.

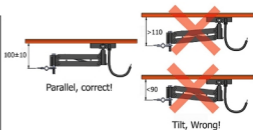
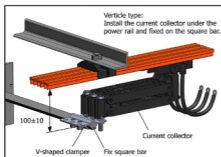

Twin type current collector:
Add one more V-shaped clammer

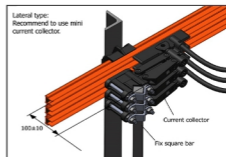

QUESTIONNAIRE

Please fill out the form. For curve tracks, we require drafts to prepare a quotation.

Company: _____ Tel: _____ Fax: _____

E-Mail: _____

1. Number of power rail installations: _____
2. Type of equipment to be powered: _____
3. Voltage: _____ V, Phases: _____, Frequency: _____ Hz AC DC
4. Track length: _____ m ; travel speed: _____ m/min. Indoor Outdoor plant
5. Number of power rails: _____ (main rails: _____ control rails: _____ ground rail: _____)
6. Type of power rail: Combine (3P-6P power rail) Power rail respectively (I type)
7. Other operating conditions (humidity, dust, chemical influence etc.)

8. Ambient temperature: _____ °C min. _____ °C max.
9. How are the rails laid out? (Please provide draft): _____
10. Power consumption of the individual consumer loads: _____ (consult page 2)
11. Max. voltage drop from the power rail feed to the consumer unit _____
12. Remarks: _____

3P Rail connector and middle power in

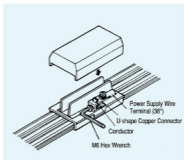
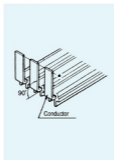
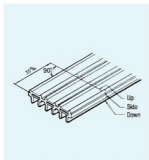

- (1) Cut off the PVC material at 35mm from the end of safety power rail.
- (2) Bend upward copper material in vertical 90° angle.
- (3) Insert both sides of 90° vertical angle safety power rail into middle power feeding and connect both sides by screwing up M6 inner hexagon screw bolt on U type copper connector.

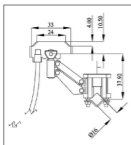

KY-AN37033

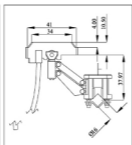

KY-AN37066



Mini Current Collector		
Type	Standard	kg/pc
KY-AN37033	30 Amp	0.14
KY-AN37066	60 Amp	0.17
KY-AN37101	100 Amp	0.27

Double set is available as photo, type for example is KY-AN37033D.

Current Collector Unit

Transit & Test System



DH-6832



DH-6813

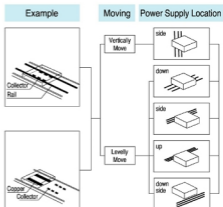
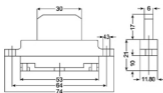

I type safety power rail installment diagram

- Vertical installment
- On Side Installment
- Vertical Installment Double
- Above Installment Guide

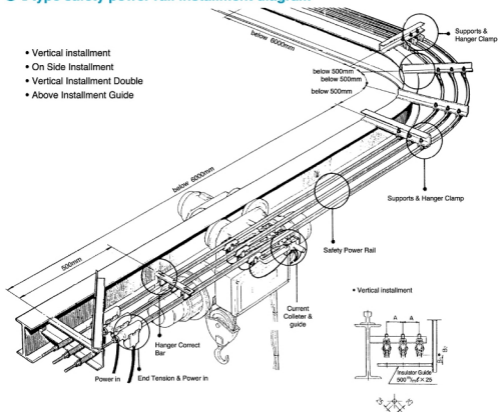

- Vertical installment



- On Side Installment

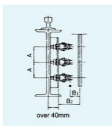

- Vertical Installment Double

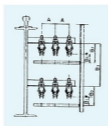

- Above Installment

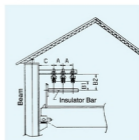

A	minimum	75
	standard	100

B	B 1	95
	B 2	130
	B 3	290

C	minimum	150
	standard	200

I type safety power rail installment diagram

Step 1 Support Design

A. installment for I type in 30 meters



B. installment for I type over 30 meters

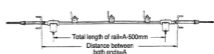

Line Case

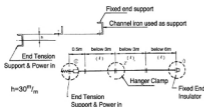

Curve Case

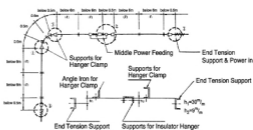

Around type

End Tension Support

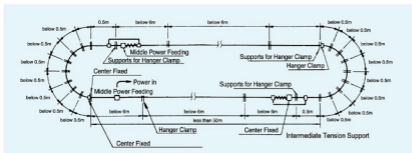

"S" type

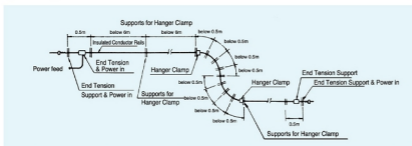

Around & Relief type

1. Distance of each hanger clamp must be under 0.5m in around type.
2. The way to pull up rail is use traverse table put on the saddle's beam, pull up the rail when crane moves. (As the commentary picture no.3 shown in end cover)

Step 2 Length in 30M

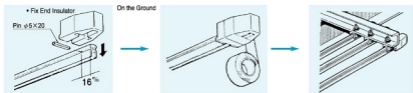

Length over 30M

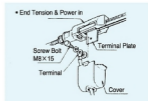
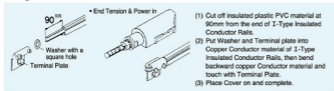

Step 3 Set & Hanger Clamp

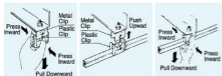

- Use tool to clip under Plastic Clip and pull I-Type Insulated Conductor Rails out together if necessary.

Middle power feed in

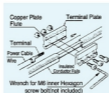

- (1) Cut off 80mm long of insulated material PVC in the middle of I-Type Insulated Conductor Rails for supplying power.
- (2) Contact Copper Conductor of I-Type Insulated Conductor Rails by two piece of Copper Plate and fix it by M6 inner hexagon screw bolt.
- (3) Drill two holes $\phi 5\text{mm}$ through both Copper Plate and Copper conductor of I-Type Insulated Conductor Rails at the bottom and insert pins to connect and fix them.

Step 4 Set, End Tension & Power in

Step 5 Set, guide & Current Collector

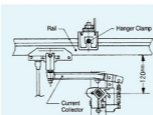
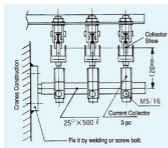

- (1) Fix square bar's angle is supposed to be mounted. One diagonal of the bar must be parallel to ground and safety power rail, another is vertical.
- (2) Length could be cut as demand.

* Caution

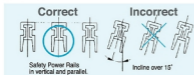

- (1) It is not allowed to incline over 15° when install I-Type Insulated Conductor Rails.
- (2) If I-Type Insulated Conductor Rails still incline after installation, then it is required to adjust forcibly.



Commentary

- ① Current Collector Set
- ② For Hoist
- ③ Around Set
- ④ For Hoist (Curve Track)
- ⑤ Amusement Grounds
- ⑥ Warehouse



KYEC

Kunyee Industrial Ltd.
<http://www.kyec-mit.com.tw>
 email : taiwan.kyec@msa.hinet.net

Head Office TEL: +886-3-3287-888 FAX: +886-3-3280-770
 Taipei Branch TEL: +886-2-2594-8345 FAX: +886-2-2596-8846
 Taichung Branch TEL: +886-4-2358-0075 FAX: +886-4-2358-2646
 Kaohsiung Branch TEL: +886-7-384-5997 FAX: +886-7-380-8729